

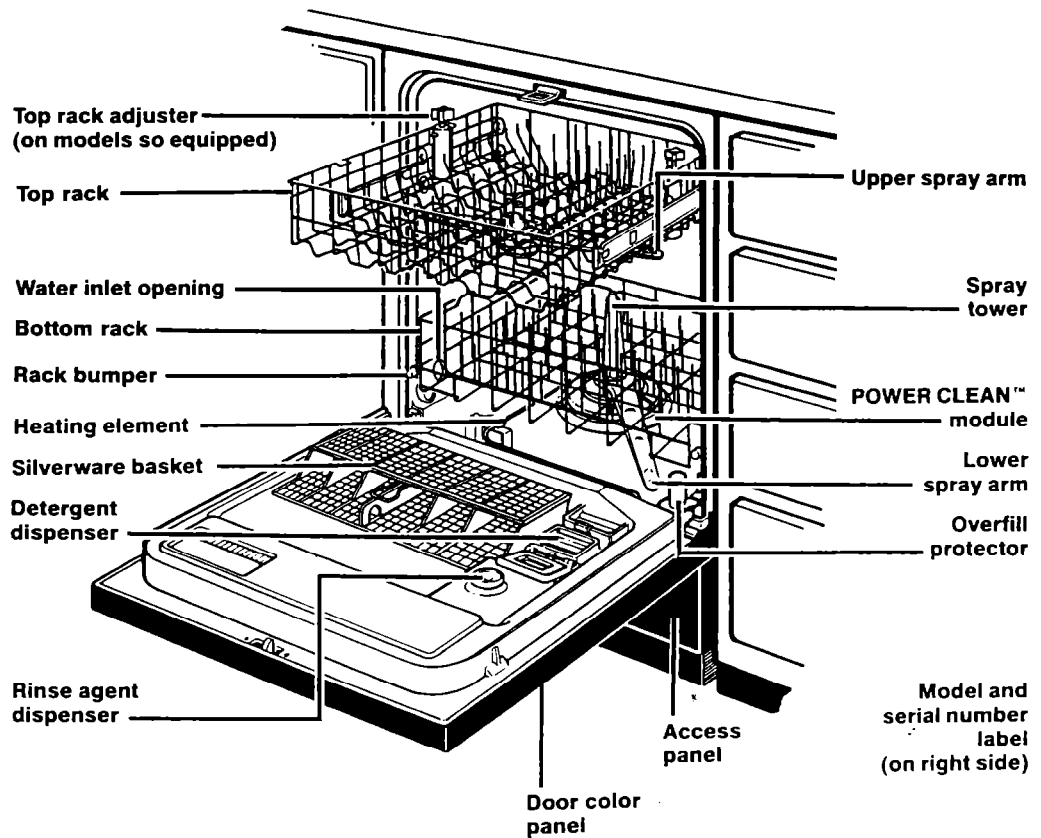

Use & Care Guide



8700 SERIES DISHWASHERS

Contents

	Page
Important Safety Instructions	3
Operating Instructions	3
Before starting your dishwasher	3
Starting your dishwasher	4
To add a dish after starting	4
Changing a cycle setting	5
Changing an option	5
Using delay wash	5
The clean signal light	5
What happens in each cycle	6
What happens in each option	8
Proper Loading	9
Adding Detergent	12
Using Rinse Agent Dispenser	13
Connecting A Portable Dishwasher	14
For Best Results	16
Special tips	16
Common Dishwashing Problems	18
If You Need Service Or Assistance	20
Whirlpool Dishwasher Warranty	24

©1993 Whirlpool Corporation

It is your responsibility to be sure your dishwasher:

- Is installed by a qualified installer.
 - Has been installed where it is protected from the elements.
 - Has been installed on a floor strong enough to support its weight.
 - Has been properly connected to electricity, water and drain.*
 - Has been properly electrically grounded.*
 - Has had all hang tags and temporary labels removed.
 - Is not used by children or anyone unable to operate it properly.
 - Is properly maintained.
- *See Installation Instructions for complete information.

Thank you for buying a Whirlpool appliance. Please complete and mail the Owner Registration Card provided with this product.

Then complete the form below. Have this information ready if you need service or call with a question.

- Copy model and serial numbers from label (see diagram on front cover) and purchase date from sales slip.
- Keep this book and sales slip together in a handy place.

Model Number

Serial Number

Purchase Date

Service Company Phone Number

If you need service, first see the "Service or Assistance" section of this book. After checking "Service or Assistance," additional help can be found by calling our Consumer Assistance Center telephone number, **1-800-253-1301**, from anywhere in the U.S.

Important Safety Instructions

⚠ WARNING

To reduce the risk of fire, electrical shock, or injury when using your dishwasher, follow basic precautions including the following:

- **Read all instructions before using the dishwasher.**
- Properly connect to electricity and water.
- **DISHWASHER MUST BE ELECTRICALLY GROUNDED.** Read the Installation Instructions for details.
- Be sure your dishwasher is installed on a level floor that will hold the weight, and in an area suitable for its size and use.
- When discarding an old dishwasher, always remove the door to prevent accidental entrapment or suffocation.
- **REMEMBER**, use your dishwasher only for the job it was designed to do.
- Store dishwasher detergent in a cool, dry place **WHERE CHILDREN CAN'T REACH IT.**
- Use **ONLY** detergents and rinse agents recommended for use in a dishwasher.
- When loading items to be washed:
 - Load sharp items and knives with the handles up to reduce risk of cut-type injuries.
 - Locate sharp items and knives so that they are not likely to damage the door seal.
- **DO NOT** let children play in or on the dishwasher.
- **DO NOT** reach into the area below the bottom rack until the heating element has cooled for at least 20 minutes.
- **DO NOT** wash plastic items unless marked "Dishwasher Safe" or the equivalent. If not marked, check manufacturer's recommendations.
- **DO NOT** use your dishwasher unless all enclosure panels are properly in place.
- **DO NOT** sit on, stand on or abuse the dishwasher door or dish racks.
- **DO NOT** tamper with controls.
- **If hot water has not been used recently (usually two weeks or longer), hydrogen gases may build up in the water heater and the hot water pipes. HYDROGEN GAS IS EXPLOSIVE. To prevent injury or damage, before using your dishwasher, turn on all hot water faucets and allow water to run for several minutes. This will allow gases to escape. Do not smoke or use any open flame near the faucet while it is open.**
- **DO NOT** store or use gasoline or other flammable vapors and liquids in the vicinity of this or any other appliance. The fumes can create a fire hazard or explosion.
- **Disconnect electrical power to the dishwasher before attempting to service.**

– SAVE THESE INSTRUCTIONS –

Operating Instructions

The drawings in this book may vary slightly from your dishwasher model. They are designed to show the different features of all the models covered by this book.

NOTE: Your model may not include all the features shown.

Before starting your dishwasher

1. Properly load the top and bottom racks, and silverware basket. See pages 9, 10 and 11.
2. Spin the Upper and Lower Spray Arms to make sure nothing will stop them from turning freely.
3. Add detergent. See page 12.
4. Check rinse agent dispenser. See page 13.
5. Push door firmly when closing and it will automatically latch.
6. Run hot water at sink nearest dishwasher until it is hot. Turn it off.
7. If your model is a portable, connect hose to faucet. Turn on hot water. See page 14. Plug in power supply cord to wall outlet. See page 15.

Operating Instructions Continued.

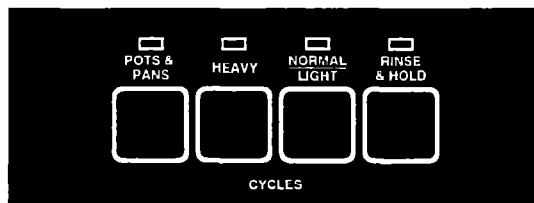

Cycle selector buttons

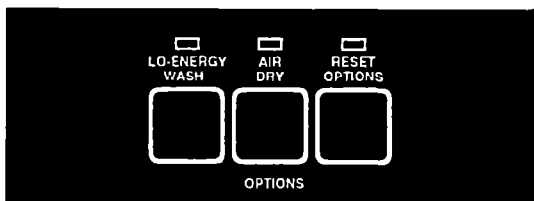

Option selector buttons

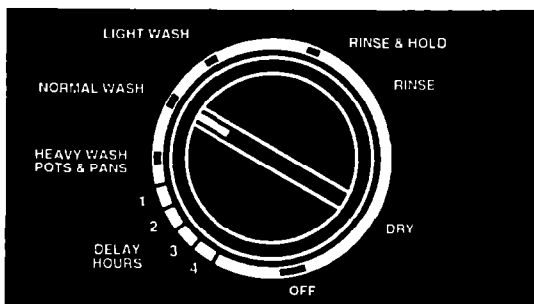

Cycle control knob

Starting your dishwasher

1. Push a Cycle Selector Button for the desired cycle. Normal Wash and Light Wash Cycles share the same button. The Cycle Control Knob determines which cycle operates.

2. Push an Option Selector Button for each desired option. The indicators above the buttons will show which cycle and option(s) have been selected.

3. Turn Cycle Control Knob clockwise to point to a desired cycle. Heavy Wash and Pots & Pans Cycles share the same spot on the dial. The Cycle Selector Buttons determine which cycle operates.

You will feel a definite stop at each cycle mark. The dishwasher will automatically start the cycle you selected.

NOTE: If the door is latched, you will hear cycles start and stop as the knob passes each cycle mark. This is normal and will not hurt the dishwasher. If you prefer, you can set cycles with the door unlatched.

To add a dish after starting

1. To be sure the added item is washed and rinsed, make sure the Cycle Control Knob has not passed LIGHT WASH.
2. Lift up on the door latch to unlatch door and stop the cycle. Don't open the door until the spray arms stop spinning.
3. Open the door and add the dish.
4. Close the door. **Do not latch it.** Wait 30 seconds for air in the dishwasher to warm up. This helps reduce the amount of moisture that can come from the vent when restarting the cycle.
5. Press door in to latch it. The dishwasher will start where it stopped.

Changing a cycle setting

You can change a setting anytime during any cycle.

1. Lift up on the door latch to unlatch the door and stop the cycle. Do not open the door until the spray arms stop spinning.
2. Turn the Cycle Control Knob clockwise to the cycle you want.
3. Be sure the detergent dispensers are filled properly for the new cycle. When changing the dial from LIGHT WASH to POTS & PANS, HEAVY WASH or NORMAL WASH setting, detergent is released. Reload covered section of dispenser before starting Pots & Pans, Heavy Wash or Normal Wash Cycles.
4. Close and latch the door. The dishwasher will automatically start the new cycle.

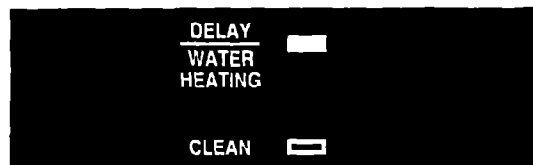
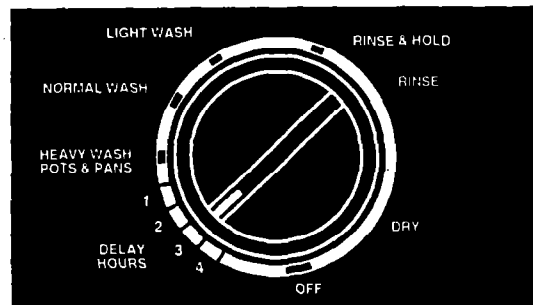
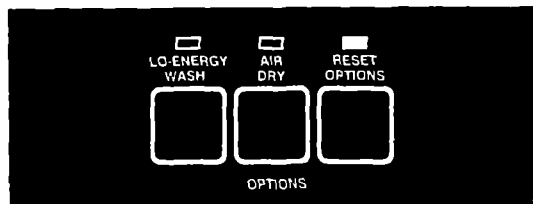

Changing an option

If you want to change a selected option, push the RESET OPTIONS Button. Re-select an option, if desired.

Using delay wash

You can set the dishwasher to start a cycle from 1 to 4 hours later.

1. Push desired Cycle Selector Button.
2. Push desired Option Selector Button(s).
3. Turn Cycle Control Knob clockwise to the number of hours (from 1 to 4 hours) you want the dishwasher to delay before the selected cycle starts.
4. Close and latch the door. The DELAY/WATER HEATING Signal Light will come on until the selected cycle starts.

NOTE:

- You can add items while time is counting down. Close and latch the door. The timer will not advance if the door is unlatched.
- Rinse & Hold and Light Wash Cycles cannot be delayed.
- The DELAY/WATER HEATING Signal Light will also come on while the water is heating during all cycles.

The clean signal light

The CLEAN Signal Light will come on when a washing cycle is complete. To turn it off, turn the Cycle Control Knob clockwise **slightly** until the light goes off.

**Operating Instructions
Continued**

What happens in each cycle

Pots & Pans Cycle

A double wash with maximum cleaning for cooked-on or baked-on foods. The Cycle Control Knob stops while the dishwasher heats water to 140°F (60°C) in both washes and the final rinse (marked †). Cycle time* is about 1½ to 2 hours, depending on the time needed to heat water.

Heavy Wash Cycle

A double wash for heavily soiled loads. The Cycle Control Knob stops while the dishwasher heats water to 140°F (60°C) in the main wash (marked †) if Lo-Energy Wash Option is not selected and in the final rinse (marked ††). Cycle time* is about 78 minutes plus the time needed to heat water.

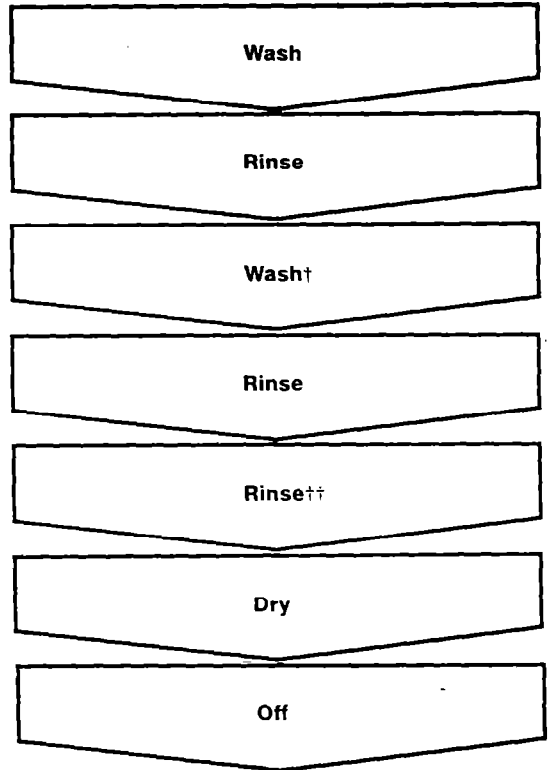
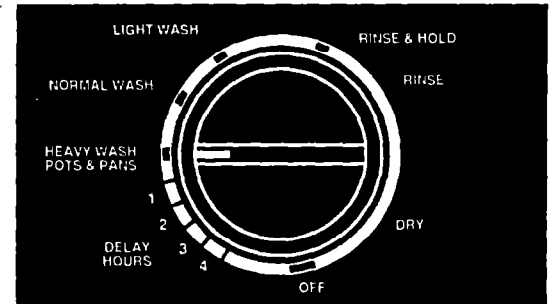
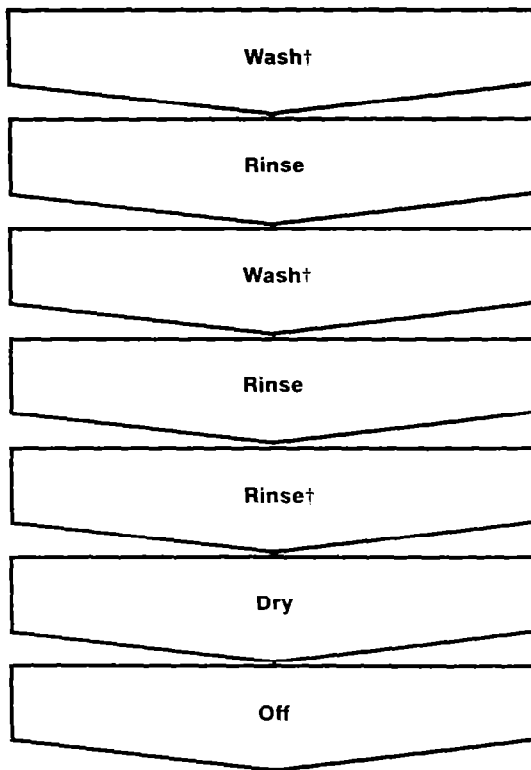
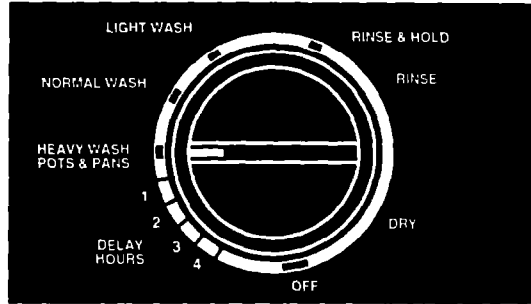

NOTE: Cycle Control Knob stops while water is heating. See "Water heating" on page 8.

*Cycle time includes heated dry times.

Normal Wash Cycle

A single wash for normal, everyday soiled loads. (The Energy Guide Label is based on this cycle.) The Cycle Control Knob stops while the dishwasher heats water to 140°F (60°C) in the wash (marked †) if Lo-Energy Wash Option is not selected and in the final rinse (marked ††). Cycle time* is about 70 minutes plus the time needed to heat water.

Light Wash Cycle

A single wash for pre-rinsed or lightly soiled loads. The Cycle Control Knob stops while the dishwasher heats water to 140°F (60°C) in the wash (marked †) if Lo-Energy Wash Option is not selected and in the final rinse (marked ††). Cycle time* is about 62 minutes plus the time needed to heat water.

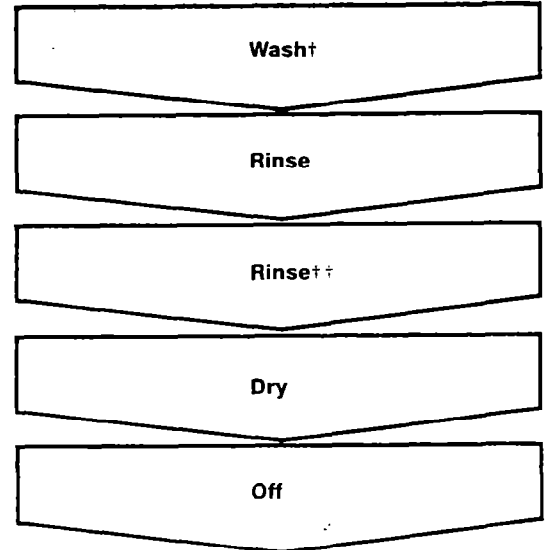
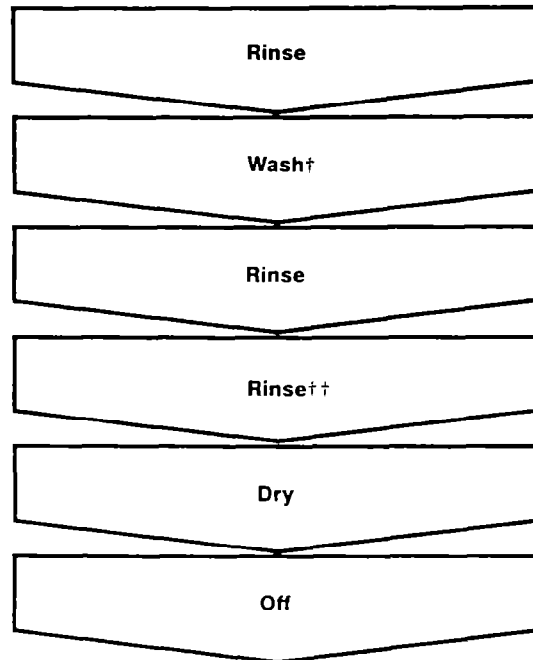
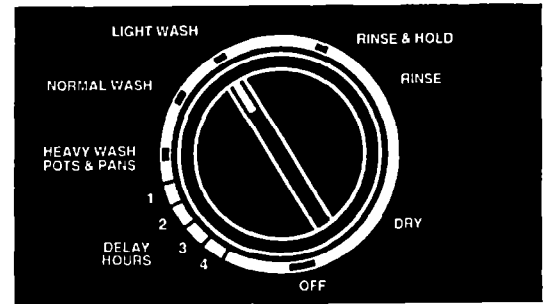
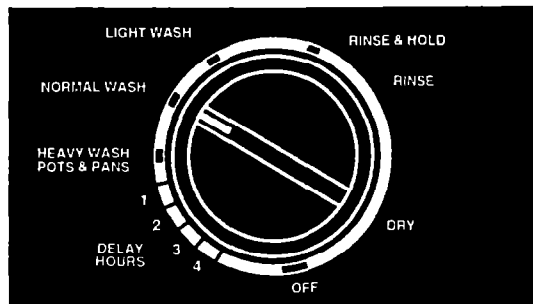

NOTE: Cycle Control Knob stops while water is heating. See "Water heating" on page 8.

*Cycle time includes heated dry time.

Operating Instructions Continued

Rinse & Hold Cycle

For rinsing a few items to be washed one or more days later. Cycle time is about 18 minutes. Do not use detergent.

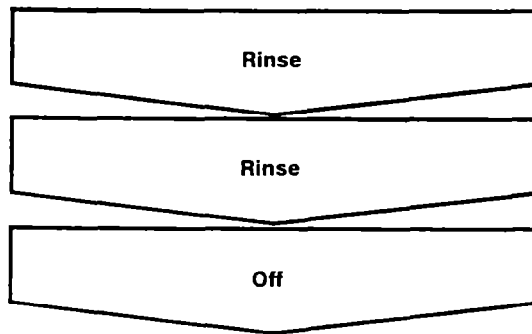
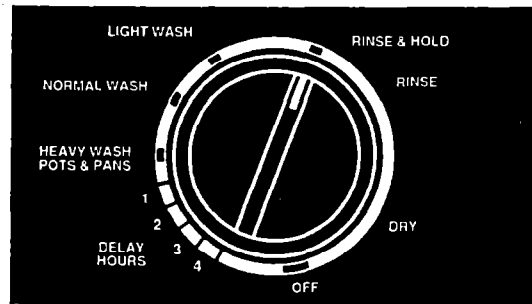

What happens in each option

Water heating

The dishwasher will heat water during portions of the Pots & Pans, Heavy Wash, Normal and Light Wash Cycles to improve washability (see pages 6 and 7). The Cycle Control Knob does not move while the water is heating. The DELAY/WATER HEATING Signal Light will come on while the water is heating.

The heating time is based on the temperature of the water supply as it enters the dishwasher. The cooler the water, the longer the heating time. When the water temperature reaches 140°F (60°C), the Cycle Control Knob will begin moving again. If the water supply is already hot enough, the dishwasher will not pause.

Lo-Energy Wash Option

The dishwasher will not heat the main wash water as described above when the Lo-Energy Wash Option is selected. This will reduce the amount of electricity needed to run the dishwasher. However, dishes may not wash as well. The final rinse will still be heated. Lo-Energy Wash Option will not work with the Pots & Pans Cycle.

Air Dry Option

Air in the dishwasher is automatically heated during the "dry" portion of all cycles except Rinse & Hold. If the Air Dry Option is selected, air in the dishwasher is not heated. Using this option helps save energy, but dishes take longer to dry (overnight) and some spotting may result. Some items (such as plastics) may need towel drying.

For best drying results, use a liquid rinse agent.

Proper Loading

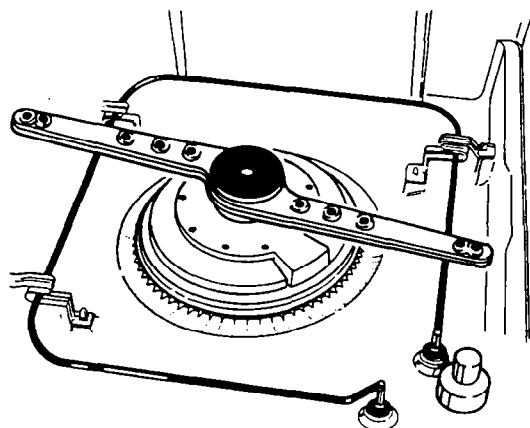

Preparation for loading

It is not necessary to rinse dishes before putting them into the dishwasher. Just remove large pieces, bones and other hard items. The POWER CLEAN™ Module will remove food particles from the water. It contains a chopping device which will reduce the size of food items.

If hard items such as fruit seeds, nuts and egg shells enter the POWER CLEAN Module, you might hear chopping, grinding, crunching or buzzing sounds. Those sounds are normal when hard items enter the module. **Do not** let metallic items (i. e. pot handle screws) get into the POWER CLEAN Module. This could result in damage to the POWER CLEAN Module.

Always load dishes so soiled surfaces are reached by spray from rotating spray arms. Water must be able to drain off completely for best drying results. Be careful to separate items so spray can reach all surfaces.

Top rack loading

The top rack is designed for cups, glasses and smaller items.

Cup and glass load

- Place so open ends face down for cleaning and draining.
- **Load glasses in top rack only.** Bottom rack is not designed for glasses. Damage may occur.
- Place items in the rows **between** prongs. Placing them **over** the prongs can lead to breakage.
- Be sure lightweight items are held firmly in place.
- China, crystal and other delicate items must not touch each other during dishwasher operation. Damage may occur.

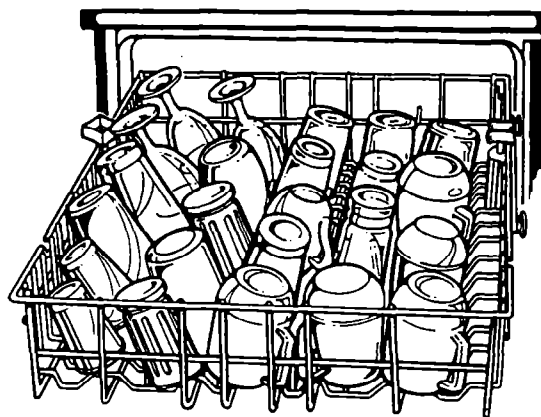

Cup and glass load

Mixed load

- Load plastic items **only in the top rack.** Only plastic items marked "dishwasher safe" are recommended.
- Load plastic items so the force of the spray does not move them during the cycle.
- Plastic items can be melted in the bottom rack.

Utensil load

- Small bowls, pans and other utensils can be placed in the top rack.

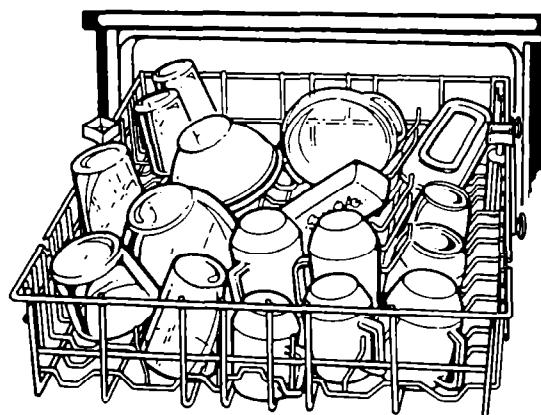

Mixed load

Proper Loading Continued

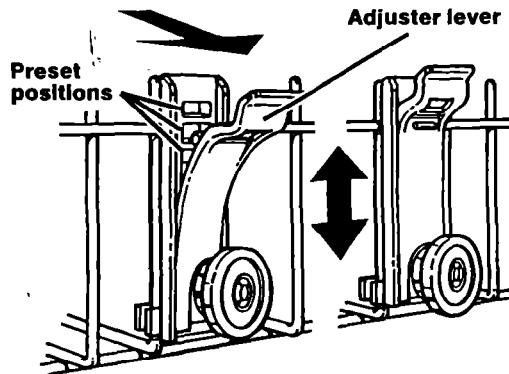

Adjustable 3-position top rack (on some models)

You can raise or lower the rack to fit tall items in either the top or bottom rack. The high and low positions are marked on the adjuster on the side facing the center of the dishwasher.

1. Hold the top rack with one hand near the adjuster.
2. Pull the top of the adjuster lever out with the other hand.
3. Lift or lower the rack to one of the preset positions.
4. Release the adjuster lever.
5. Repeat steps 1-4 for the three remaining adjusters as needed. The four adjusters can be raised or lowered separately or together, as desired.

Infinite adjustable top rack (on models so equipped)

The top rack does not have to be level.

- Raise or lower one or both sides to help fit tall items in the top or bottom rack.
- Turn knob clockwise to raise a side.
- Turn knob counterclockwise to lower a side.

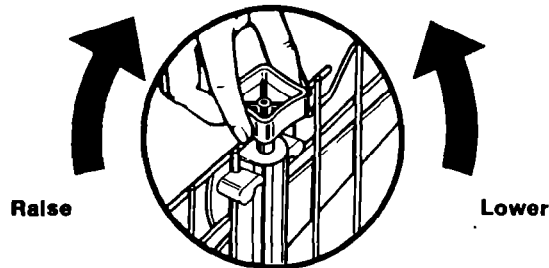

Bottom rack loading

Items with cooked-on or dried-on food should be loaded in the bottom rack, with soiled surfaces facing inward to the spray.

Mixed load

- Make sure pot handles and other items do not stop rotation of either the upper or lower spray arm. Spray arms must move freely.
- Load items so they do not block or cover the spray tower.
- Securely place heavily soiled cookware face down in rack.

Dish load

- Place plates, soup bowls, etc., **between** prongs and facing inward to the spray.
- Do not place items directly over spray tower.

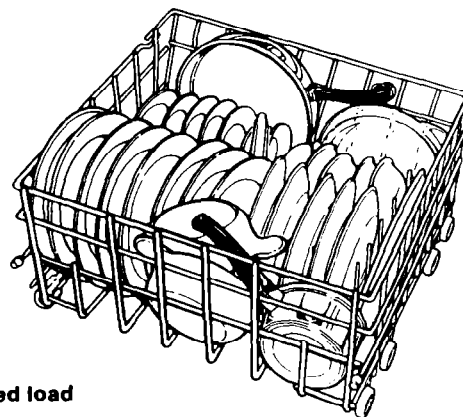

Mixed load

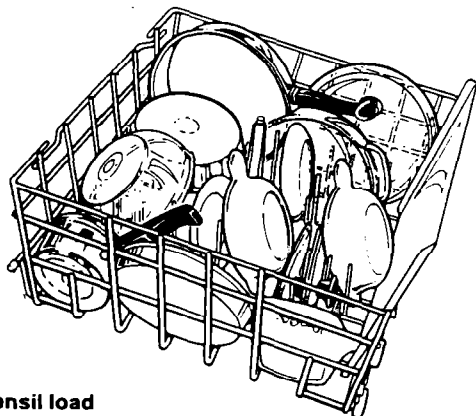

Utensil load

Utensil load

- Load cookie sheets, cake pans and other large items at sides and back. Loading such items in front may keep water spray from reaching detergent dispenser and silverware basket.

NOTE:

- Do not load glasses, cups or plastic items in the bottom rack.
- When lower rack is removed, replace with bumpers in front.

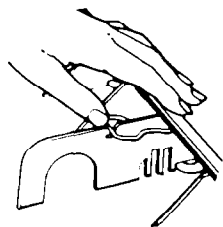
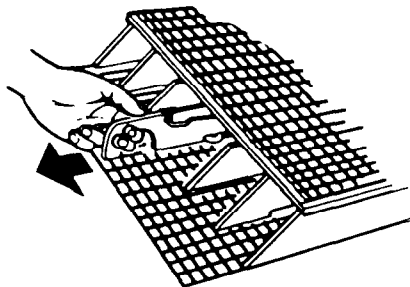
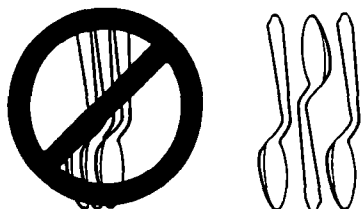

Silverware basket loading

Load forks and spoons so they **don't nest together**. Spray can't reach nested items.

Mix items in each section of the basket. Small items – baby bottle caps, jar lids, etc. – can be put in any section.

The silverware basket can be loaded while it's in place on the door, or it can be taken out for loading on the counter or table.

It can also be removed for easy unloading.

Always unload or remove the basket before unloading the racks to avoid spilling water droplets on the silverware.

To remove the basket, slide it toward the top of the door – by the handle. Lift it off the holding buttons.

To replace the basket, set it on the holding buttons. Slide the basket toward the bottom of the door until it locks in place.

To open the basket, unhook the latch as shown. Be sure the cover is completely latched before pulling out the bottom rack and before closing the dishwasher door.

⚠ WARNING

Personal Injury Hazard

To avoid cuts from sharp items (knives, forks, skewers, etc.), make sure these items are put in point down.

Adding Detergent

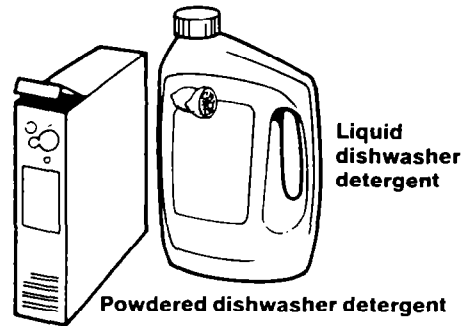

Liquid dishwasher detergent

Powdered dishwasher detergent

See phosphorus content on product labels.

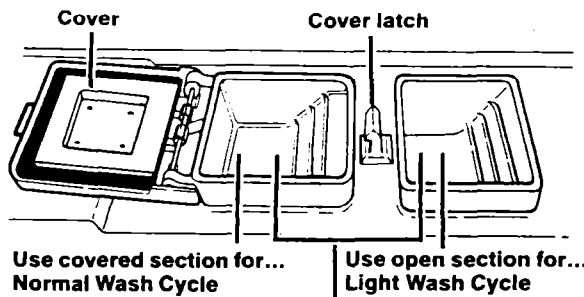

Use covered section for...
Normal Wash Cycle

Use open section for...
Light Wash Cycle

Use both sections for...
Pots & Pans Cycle
Heavy Wash Cycle

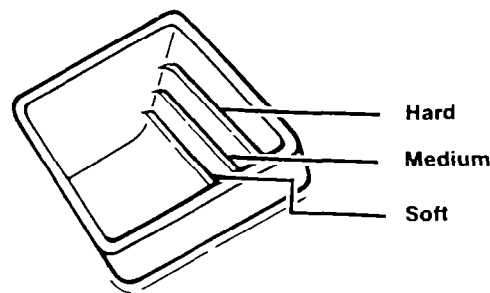

Hard

Medium

Soft

What kind of detergent to use

Use automatic dishwasher detergent only.

Other detergents are too mild and much too sudsy to work in the dishwasher.

Different brands of dishwasher detergent have different amounts of phosphorus for softening water. If water is hard and phosphorus content is low (6.0% or less), you may need to use more detergent or use a brand with a higher phosphorus content (8.7% or higher).

Do not add detergent until you are ready to wash. **Fresh automatic dishwasher detergent is necessary for best washing results.** Store detergent tightly closed in a cool, dry place.

The detergent dispenser

The detergent dispenser has one section with a cover and one without.

- For cycles with one wash, put detergent in one section only.
 - Use the **open** section if the cycle begins with a wash.
 - Use the **covered** section if the cycle begins with a rinse.
- For cycles with two washes, put detergent in both sections.
- Push the cover down until it is latched.

Detergent in the open section falls into the dishwasher when the door is closed. The covered section opens automatically when the main wash starts.

NOTE: It is normal for the cover to open partially when dispensing detergent. The cover will open fully when the door is opened.

How much detergent to use

The amount of detergent to use depends on the hardness of your water. If too little is used, dishes won't be clean. However, if too much is used in soft water, glassware will begin to etch.

Find out your water's hardness by asking your local water department, water softener company or county extension agent.

- **HARD** – Fill 1 or both sections to top line if water hardness is 8 or more grains per gallon, or 136 or more parts per million.
- **MEDIUM** – Fill 1 or both sections to middle line if water hardness is 5 to 7 grains per gallon, or 85 to 119 parts per million.
- **SOFT** – Fill 1 or both sections to bottom line if water hardness is 0 to 4 grains per gallon, or 0 to 68 parts per million.

Using Rinse Agent Dispenser

Rinse agent dispenser

Keep the rinse agent dispenser filled with a liquid rinse agent. **A rinse agent greatly improves the drying of dishes by helping water flow off of them during the last rinse.** A rinse agent also keeps water from forming droplets and drying as spots. A small amount of rinse agent is automatically released into the rinse water during the final rinse of each cycle.

For best drying results, check the dispenser periodically to see if it needs refilling.

To check dispenser

The center of the Fill Indicator Cap will be clear when dispenser needs refilling. An "E" will also be visible inside the dispenser when the cap is removed and the dispenser is empty.

On some models:

1. Press the flexible clear top of the Fill Indicator Cap to draw rinse agent into cap.

NOTE: You may need to press cap two or three times to remove all of the air bubbles from the cap.

2. When rinse agent does not show in cap, even after pressing flexible cap several times, dispenser needs refilling.

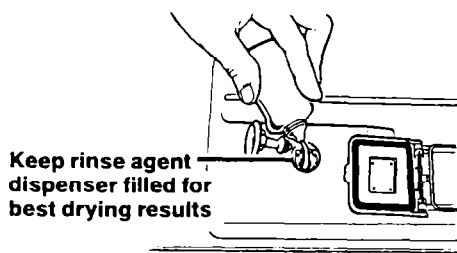
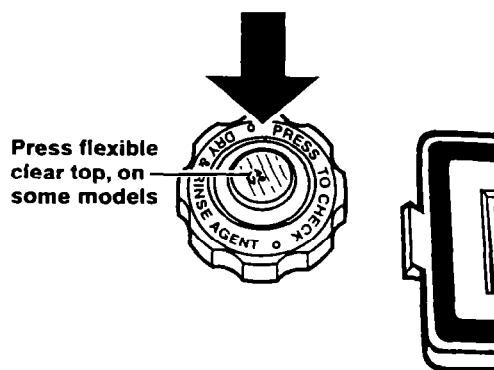

To fill dispenser

The dispenser will hold 6 ounces of rinse agent. Under normal conditions, this will last about 3 months. You do not have to wait until the dispenser is empty to refill it, but do not overfill it.

Make sure the dishwasher door is fully open before removing the Fill Indicator Cap. Do not fill past the smallest opening in the lower part of the dispenser. If you overfill, excess rinse agent can come out. This will not harm the dishwasher, but could cause over-sudsing. Clean up any spilled rinse agent with a damp cloth. Replace the Fill Indicator Cap and keep it tightly closed.

NOTE: Because your dishwasher is designed to use a liquid rinse agent, you do not need to use a solid or bar-type rinse agent.

Connecting A Portable Dishwasher

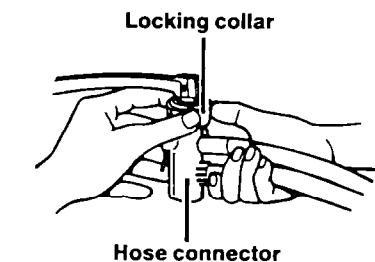
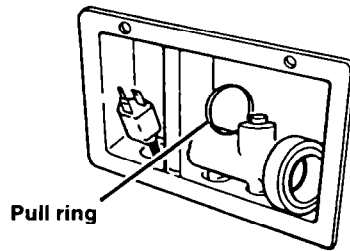
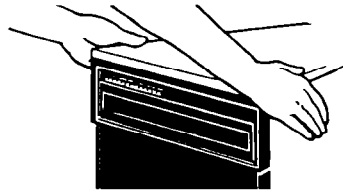

A special adapter must be installed on the faucet before the dishwasher can be connected. Complete instructions and the adapter are packed with your dishwasher.

When moving your dishwasher, make sure the door is latched. Hold the dishwasher at the top front corners.

Before starting

1. Run water at faucet until it is **hot**. Turn it off.
2. Pull hoses out of their storage compartment on the back.
3. Pull down on the locking collar while lifting the hose connector onto the faucet adapter.
4. When the connector snaps into place, release the locking collar.
5. Turn the **hot** water on slowly until it is **all the way on**.
6. Plug in power supply cord.
7. See pages 3 and 4 to start the dishwasher.

While dishwasher is running

You can draw water from the faucet while the dishwasher is connected. **Do not** draw water while the dishwasher is filling or while water is being pumped out. (This helps prevent a low fill when dishwasher is filling, or mixing drain water with fresh water.)

1. Press red button on hose connector to get the water you want. (The faucet is set on hot. Adjust faucet for the water you want.)
2. **Be sure you return cold water to off, and that hot water is full on.**

When cycle is finished

1. Turn hot water off. (This can be done after the last rinse.)
2. Press the red button on the connector to release the water pressure.
3. Lift slightly on the hose connector while pulling down the locking collar. Pull down on the connector.
4. Empty any remaining water from the connector.
5. Unplug power supply cord and return to storage compartment.
6. Return hoses to storage compartment.

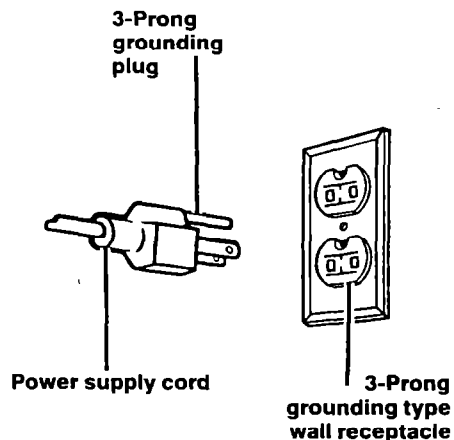

Electrical Connection

A power supply of 120 volts, 60Hz AC, 15 or 20 amps, is required. For your personal safety, this appliance must be grounded. This appliance is equipped with a power supply cord having a 3-prong grounding plug. To minimize possible shock hazard it must be plugged into a mating 3-prong grounding type wall receptacle, grounded in accordance with the National Electrical Code and local codes and ordinances. If a mating wall receptacle is not available, it is the responsibility and obligation of the customer to have a properly grounded 3-prong wall receptacle installed by a qualified electrician.

⚠ WARNING

Personal Injury Hazard

An extension cord should not be used with this appliance. Such use may result in a fire, electrical shock or other personal injury.

Do not, under any circumstances, remove the power supply cord ground prong.

Converting to built-in

Your Whirlpool Portable Dishwasher can be converted to a built-in (undercounter) model by using conversion kit No. 4317856. The kit is available at your Whirlpool dealer or authorized WhirlpoolSM service company. Instructions are included with the kit.

Caring for simulated wood top

The simulated wood top can be used as a utility work surface for most kitchen jobs. It is stronger and more easily cleaned than genuine wood.

The top can be used as a cutting board. Knife marks will be visible but will not seriously damage top. Hot items from the oven can be placed on the top.

Clean with warm, soapy water. For dried-on foods, use a scouring pad.

For Best Results

Hot water is a must

Hot water dissolves and activates the dishwashing detergent. Hot water dissolves grease on dishes and helps dry glasses spot-free. Make certain loads are washed in hot water. Two ways to have a reliable hot water supply...

1. Maintain a 140°F (60°C) water supply at central water heater. To check water temperature, turn on hot water faucet nearest the dishwasher. Let water run until it is as hot as possible, then check with a candy or meat thermometer. If the temperature at the faucet is below 135°F (57°C), have a qualified person raise the water heater thermostat setting.
2. Do not use Lo-Energy Wash Option. When this option is off, a thermostat will delay the cycle while the dishwasher heats the water until the temperature reaches 140°F (60°C).

NOTE: When Lo-Energy Option is off and the water is hot enough at the start, the cycle will proceed with no delay. This lets you turn down your water heater, if you choose, without cutting back on hot water needed for good dishwashing.

Quiet operating tips

To avoid thumping and clattering noises during operation:

- Make sure lightweight load items are secured in the rack.
- Make sure pot lids and handles, pizza pans, cookie sheets, etc. do not touch interior walls or interfere with either of the spray arms rotation.
- Load dishes so they **don't** touch one another.

NOTE: Keep sink drain plugs inserted during dishwasher operation to prevent noise transfer through drains.

Special tips

Remember, use your dishwasher only for the job it was designed to do. Some items are not dishwasher safe or may require special care. Read these special tips for the following items:

Aluminum: Aluminum loses its bright, shiny appearance and darkens in color due to minerals in the water and the alkalinity of the dishwasher detergent. Colored aluminum may fade.

TIPS: If washed in the dishwasher avoid placing directly in front of detergent dispenser where it could be sprinkled with undissolved detergent, causing spotting, pitting, and discoloration. Follow utensil manufacturer's cleaning instructions.

China: Check manufacturer's recommendations. Hand-painted, metal-trimmed, and antique china fade due to high water temperatures and alkaline detergent solution in the dishwasher.

NOTE: Delicate, antique items should not be washed in the dishwasher.

TIPS: Load china carefully. **Do not** allow pieces to touch each other. Test one piece by washing it daily in the dishwasher for several weeks. Then compare it with the rest of the set to see if colors have changed.

Crystal and decorative glasses: Crystal can break from sudden exposure to high water temperature. Metal trim and colorful decoration on glass will fade in time when washed in the dishwasher.

NOTE: Delicate, antique items should not be washed in the dishwasher.

TIPS: Load crystal carefully in **top rack only**. Be sure to load a few larger items in the bottom rack to reduce amount of force of water spray reaching glassware from lower spray arm. Use the shortest cycle.

Flatware: Salty and acidic food may tarnish silver and stainless flatware if allowed to remain on the utensils. A film may form on sterling silver and silver plate items washed in a dishwasher. This film is caused by reaction of silver with chlorine in the detergent. **Gold flatware is not dishwasher safe.** The adhesive used in some flatware with hollow handles is not heat resistant, causing the handles to come off in the dishwasher. Wash by hand.

TIPS: Rinse flatware as soon as possible, especially if it is not to be washed right away. Dishwasher detergent may remove antique finishes. Wash by hand. Tarnish and film build-up can be removed with silver polish.

Cast iron utensils: The seasoned finish will be removed in the dishwasher. Rusting will result.

TIPS: Wash by hand. To re-season, coat with unsalted fat and heat in a slow oven for an hour or two.

Plastics: Many plastics will have "Dishwasher Safe" written on them. Some plastics are heat sensitive and may melt or warp.

TIPS: If in doubt, try one piece. Place in upper rack only. Air Dry Option provides additional protection.

Non-stick finish utensils: Most can be washed in the dishwasher.

TIPS: Follow manufacturer's suggestions.

Bottles and cans: Items with glued-on labels should not be washed in your dishwasher. Labels can loosen during a wash and clog spray arms and the pump. A clogged spray arm or pump will reduce washing performance.

TIPS: Rinse by hand or remove label before placing item in dishwasher.

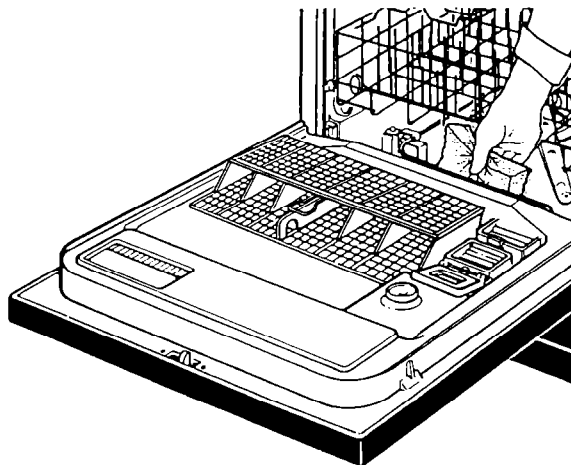
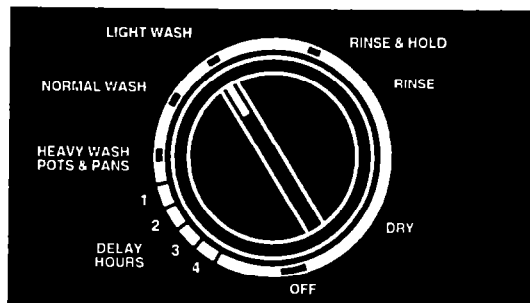

Wood: Many wooden items will crack and warp or lose their finish.

TIPS: Do not wash cutting boards, wooden salad bowls or knives, with wooden handles in the dishwasher.

Pewter or pewter-like materials: Items may streak, discolor, and pit.

TIPS: To keep pewter at its very best, hand wash with mild detergent.

Energy saving tips

You can help save energy if you:

- 1. Wash full loads.** Running a half-filled dishwasher uses the same amount of electricity and hot water as a fully loaded machine.
- 2. Use the Light Wash Cycle whenever possible.** It uses less hot water and energy than other cycles.
- 3. Air dry dishes** when you don't need a rapid drying cycle. Allow longer drying times (overnight). Use a rinse agent to improve drying.
- 4. Load correctly** for best washing results. Incorrect loading may cause poor washing and the need to rewash all or part of the load.
- 5. Do not pre-rinse normally soiled dishes.** Select the correct cycle for the load and use the recommended amount of detergent for good washing results without hand rinsing.
- 6. Use your dishwasher** during off-peak hours. Local utilities recommend this to avoid heavy usage of energy at certain times of day.
- 7. Select the Lo-Energy Wash Option.** The automatic water heating in the main wash will be turned off.

NOTE: Loads may not wash as well if the water temperature is too low.

Dishwasher care & cleaning

Exterior – Regular use of a soft, damp cloth or sponge and a mild detergent is all that is necessary, in most cases, to keep the outside of your dishwasher nice looking and clean.

Interior – Hard water minerals may cause a white film to build-up on the inside surfaces, especially just beneath the door area. To clean dishwasher interior:

1. Apply powdered dishwasher detergent to a damp sponge to make a paste.
OR
2. Use liquid automatic dishwasher detergent and clean with damp sponge.

Wear rubber gloves. **Do not** use any type of cleanser other than automatic dishwasher detergent because it may cause foaming or sudsing.

Common Dishwashing Problems

Spotting and filming

Hard water

Fill detergent dispensers to capacity. Use dishwasher detergent with highest available phosphorus content. May be necessary to install water softener.

To remove spots and film, try a vinegar rinse...

1. Wash and rinse load as usual. Use Air Dry Option.
2. Remove all metal items.
3. Put 2 cups (500 mL) white vinegar in a container on the bottom rack.
4. Run dishwasher through a complete washing cycle.

Water is not hot enough

Water temperature should be at least 140°F (60°C). Set water heater thermostat to a higher setting. Run water at sink until hot before starting and **do not** use Lo-Energy Wash Option.

Not enough detergent, or improper detergent

Use more dishwasher detergent. Use detergent with highest available phosphorus content... especially with hard water.

"Old" detergent

Use only fresh dishwasher detergent. Store **tightly closed** container, in cool, dry place. Discard old detergent. Do not fill dispensers until ready to start dishwasher.

Improper loading

Make sure dishes and glassware are loaded so spray reaches all surfaces and items drain properly. Do not overload. Do not nest items. Make sure large items do not block spray from reaching detergent dispensers.

No rinse agent

Does the rinse agent dispenser need filling? See instructions on page 13.

AIR DRY Setting used

Drying without heat may result in some spotting of glasses and silver.

Small particles deposited on items

Spray arm not rotating freely

Check spray arms to make sure they turn freely after loading. Be sure a utensil has not prevented their turning.

"Old" detergent

Use only fresh dishwasher detergent. Store **tightly closed** container, in cool, dry place. Discard old detergent. Do not fill dispensers until ready to start dishwasher.

Not enough detergent, or improper detergent

Use more dishwasher detergent. Use detergent with highest available phosphorus content... especially with hard water.

Water is not hot enough

Water temperature should be at least 140°F (60°C). Set water heater thermostat to a higher setting. Run water at sink until hot before starting and **do not** use Lo-Energy Wash Option.

Water pressure may be low, dishwasher is not filling properly

If water pressure is low, do not use water for other purposes while dishwasher is running (to assure correct fills).

Dishes not dry

No rinse agent

Does the rinse agent dispenser need filling? See instructions on page 13.

Water is not hot enough

Water temperature should be at least 140°F (60°C). Set water heater thermostat to a higher setting. Run water at sink until hot before starting.

Improper loading

Make sure dishes and glassware are loaded so spray reaches all surfaces and items drain properly. Do not overload. Do not nest items.

AIR DRY Setting used

Allow more time when using Air Dry Option, or use Heat Dry Option. Plastic items may need towel drying.

Black marks on dishes

Aluminum utensils rubbing against items during washing

Use care in loading aluminum utensils, especially any lightweight foil container. Place so they do not touch dishes. Remove black marks with plastic scouring pad and a mild abrasive cleanser.

Chipping or breaking glassware

Improper loading

Do not overload. Load glasses in the top rack only. Load between prongs, not over them. Glasses loaded over prongs will not be supported and may chip or break.

Dishes not washing clean**Water is not hot enough**

Water temperature should be at least 140°F (60°C). Set water heater thermostat to a higher setting. Run water at sink until hot before starting and **do not** use Lo-Energy Wash Option.

Improper loading

Make sure dishes and glassware are loaded so spray reaches all surfaces and items drain properly. Do not overload. Do not nest items. Make sure large items do not block spray from reaching detergent dispensers.

Spray arm or arms not rotating freely

Check spray arms to make sure they turn freely after loading. Be sure a utensil has not prevented their turning.

Not enough detergent or improper detergent

Use more dishwasher detergent. Use detergent with highest available phosphorus content... especially with hard water.

“Old” detergent

Use only fresh dishwasher detergent. Store **tightly closed** container, in cool, dry place. Discard old detergent. Do not fill dispensers until ready to start dishwasher.

Water pressure may be low, dishwasher is not filling properly

If water pressure is low, do not use water for other purposes while dishwasher is running (to assure correct fills).

Cloudy film on glassware, etching – permanent corrosion**Too much detergent in soft water**

Check for rainbow hue on glasses. A rainbow hue is the first sign of etching (corrosion of glass). Reduce the amount of dishwasher detergent. Use a detergent with a lower phosphorus content.

Inadequate rinsing

If water pressure is low do not use water for other purposes while dishwasher is running (to assure correct water fills). Make sure dishes and glassware are loaded properly to assure adequate rinsing and draining. Do not overload.

Dishes & interior of dishwasher yellow or brown**Iron or manganese in water****Temporary remedy:**

1. Set empty dishwasher for a “one wash” cycle.

2. Start dishwasher and unlatch door to stop it when it has filled for the wash part of the cycle.
3. Add ¼ to ½ cup (120 to 240 mL) of citric acid crystals (usually available in drugstores).
4. Close and latch door to complete cycle.

Permanent solution: Install an iron or manganese filter or water softener to home water supply.

Rust spots on stainless steel – OR – Dark spots on flatware: stainless steel, silver plate, or sterling**Allowing salty or acidic foods such as mayonnaise, vinegar, fruit juices, salad dressings, milk products to remain on flatware**

Rinse flatware that is to stand for several hours before washing (use the Rinse & Hold Cycle). Clean stained items with silver polish and re-wash. **Do not** put stainless steel and silver flatware in the same silverware basket compartment. Direct contact between these metals can cause permanent damage to the silver.

Undissolved detergent coming in contact with flatware

Remove spots with silver polish. Avoid spilling concentrated detergent on wet flatware.

Bronze tarnish on silverplate**Silverplate is worn off. Exposed base metal takes on a bronzed hue**

Remove tarnish with silver polish. Have silver replated.

Water left in bottom of dishwasher above grate**Dishwasher cycle not completed**

Allow dishwasher to complete cycle. Some remaining water is normal and keeps seals from drying.

Clogged drain air gap

Some plumbing codes require use of a drain air gap between an **undercounter** dishwasher and the drain system of the house. The air gap is usually located above the sink or on the top of the counter near the dishwasher to prevent the possibility of water backing up from the drain into the dishwasher due to a plugged drain. The drain air gap is **not** a part of the dishwasher and is **not** covered by the dishwasher warranty. The drain air gap should be kept clean to ensure proper draining of the dishwasher.

If You Need Service Or Assistance

We suggest you follow these steps:

1. Before calling for assistance...

Performance problems often result from little things you can find and fix yourself without tools of any kind.

If your dishwasher will not run, or stops during a cycle:

- Is the door tightly closed and securely latched?
- Has the cycle been correctly set?
- Is the water turned on?
- Have you checked your home's main fuses or circuit breaker box?
- Is the dishwasher connected to a live circuit with the proper voltage?
- If the motor has stopped because of an overload, it will automatically reset itself within a few minutes. If the motor does not start, call for service.

If your dishwasher seems to run too long:

- Have you selected the Lo-Energy Wash Option? The dishwasher may be waiting for the water to heat.

If dishwasher won't fill:

- Is overflow protector stuck in "up" position? Overflow protector should move up and down freely. Press down to release.

If water remains in the dishwasher:

- Has the cycle completed?
- A small amount of remaining water is normal.
- Is drain air gap clogged?

If detergent remains in the covered detergent cup:

- Is the bottom rack in backwards? (The rack bumpers should be at the front.)
- Is the dishwasher detergent fresh and dry without lumps?
- Is the cycle completed?

If white residue appears on front of access panel:

- Is more detergent being used than needed? See page 12 for recommended amounts of detergent.
- Some liquid detergents develop excess foam and build up on exterior of access panel. Try a different brand to reduce foaming and eliminate build-up.

If you hear grinding, grating, crunching, buzzing sounds:

- A hard object has probably entered the POWER CLEAN™ Module. The sound should stop when the object is ground up.

If dishes aren't as dry as you expected:

- Is the rinse agent dispenser filled? Using a rinse agent greatly improves drying. (See page 13.)

2. If you need assistance*...

Call Whirlpool Consumer Assistance Center telephone number. Dial free from anywhere in the U.S.:

1-800-253-1301

and talk with one of our trained consultants. The consultant can instruct you in how to obtain satisfactory operation from your appliance or, if service is necessary, recommend a qualified service company in your area.

If you prefer, write to:

Mr. William Clark
Consumer Assistance Representative
Whirlpool Corporation
2000 M-63
Benton Harbor, MI 49022

Please include a daytime phone number in your correspondence.

3. If you need service*...



Whirlpool has a nationwide network of authorized WhirlpoolSM service companies. Whirlpool service technicians are trained to fulfill the product warranty

and provide after-warranty service, anywhere in the United States. To locate the authorized Whirlpool service company in your area, call our Consumer Assistance Center telephone number (see Step 2) or look in your telephone directory Yellow Pages under:

APPLIANCES – HOUSEHOLD – MAJOR – SERVICE & REPAIR **ELECTRICAL APPLIANCES – MAJOR – REPAIRING & PARTS**
OR
WASHING MACHINES, DRYERS & IRONERS – SERVICING
WHIRLPOOL APPLIANCES AUTHORIZED WHIRLPOOL SERVICE
SERVICE COMPANIES
 XYZ SERVICE CO
 123 MAPLE 999-9999

4. If you need FSP® replacement parts*...

FSP is a registered trademark of Whirlpool Corporation for quality parts. Look for this symbol of quality whenever you need a replacement part for your Whirlpool appliance. FSP replacement parts will fit right and work right, because they are made to the same exacting specifications used to build every new Whirlpool appliance.

To locate FSP replacement parts in your area, refer to Step 3 above or call the Whirlpool Consumer Assistance Center number in Step 2.

5. If you are not satisfied with how the problem was solved*..

- Contact the Major Appliance Consumer Action Panel (MACAP). MACAP is a group of independent consumer experts that voices consumer views at the highest levels of the major appliance industry.
- Contact MACAP only when the dealer, authorized servicer and Whirlpool have failed to resolve your problem.
 Major Appliance Consumer Action Panel
 20 North Wacker Drive
 Chicago, IL 60606
- MACAP will in turn inform us of your action.

*When requesting assistance, please provide: model number, serial number, date of purchase, and a complete description of the problem. This information is needed in order to better respond to your request.

POWER CLEAN™ washing system parts covered by your warranty

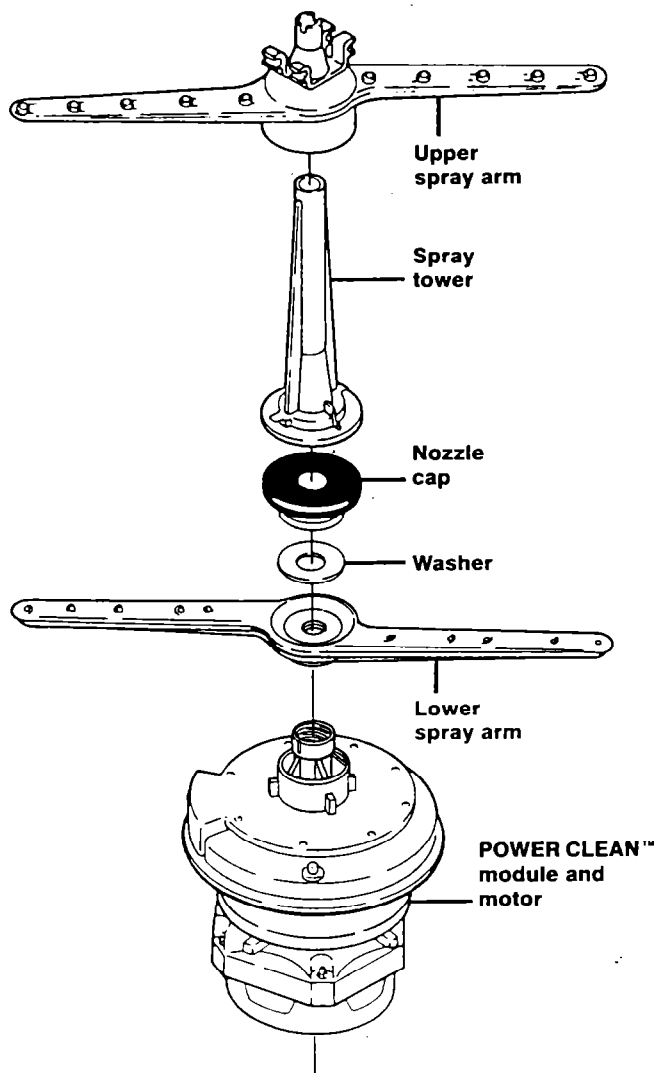

WHIRLPOOL® Dishwasher Warranty

LENGTH OF WARRANTY	WHIRLPOOL WILL PAY FOR
FULL ONE-YEAR WARRANTY From Date of Purchase	FSP® replacement parts and repair labor to correct defects in materials or workmanship. Service must be provided by an authorized Whirlpool SM service company.
LIMITED ONE-YEAR WARRANTY Second Year From Date of Purchase	FSP replacement parts for any part of the POWER CLEAN™ Washing System if defective in materials or workmanship. These parts are shown on page 23 of this book.
LIMITED FOUR-YEAR WARRANTY Second Through Fifth Year From Date of Purchase	For models with platinum nylon coated dishracks, FSP replacement parts for the upper and/or lower dishracks if they rust due to defective materials or workmanship.
FULL TWENTY-YEAR WARRANTY From Date of Purchase	FSP replacement parts and repair labor for the DURAPERM™ tub and/or inner door should they fail to contain water due to defective materials or workmanship. Service must be provided by an authorized Whirlpool service company.
WHIRLPOOL WILL NOT PAY FOR	
<p>A. Service calls to:</p> <ol style="list-style-type: none"> 1. Correct the installation of the dishwasher. 2. Instruct you how to use the dishwasher. 3. Replace house fuses or correct house wiring or plumbing. <p>B. Repairs when dishwasher is used in other than normal, single-family household use.</p> <p>C. Pick up and delivery. This product is designed to be repaired in the home.</p> <p>D. Damage to dishwasher caused by accident, misuse, fire, flood, acts of God or use of products not approved by Whirlpool.</p> <p>E. Any labor costs during limited warranty.</p> <p>F. Repairs to parts or systems caused by unauthorized modifications made to the appliance.</p>	

5/93

WHIRLPOOL CORPORATION SHALL NOT BE LIABLE FOR INCIDENTAL OR CONSEQUENTIAL DAMAGES. Some states do not allow the exclusion or limitation of accidental or consequential damages so this limitation or exclusion may not apply to you. This warranty gives you specific legal rights, and you may also have other rights which vary from state to state.

Outside the United States, a different warranty may apply. For details, please contact your authorized Whirlpool distributor or military exchange.

If you need service, first see the "Service or Assistance" section of this book. After checking "Service or Assistance," additional help can be found by calling our Consumer Assistance Center telephone number, **1-800-253-1301**, from anywhere in the U.S.

® Registered Trademark/TM Trademark/SM Service Mark of Whirlpool Corporation

Part No. 3373748
©1993 Whirlpool Corporation

Printed in U.S.A.